

Cat. No. 42-4039 A
OWNER'S MANUAL

Please read before using this equipment.

Electronic Keyboard

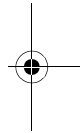

MD-1150

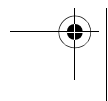
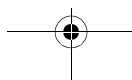
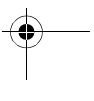

OPTIMUS®



WARNING: To reduce the risk of fire or shock hazard, do not expose this product to rain or moisture.

	CAUTION RISK OF ELECTRIC SHOCK. DO NOT OPEN.	
CAUTION: TO REDUCE THE RISK OF ELECTRIC SHOCK, DO NOT REMOVE COVER OR BACK. NO USER-SERVICEABLE PARTS INSIDE. REFER SERVICING TO QUALIFIED PERSONNEL.		



This symbol is intended to alert you to the presence of uninsulated dangerous voltage within the product's enclosure that might be of sufficient magnitude to constitute a risk of electric shock. Do not open the product's case.



This symbol is intended to inform you that important operating and maintenance instructions are included in the literature accompanying this product.

We recommend you record your keyboard's serial number here. The number is in the battery compartment of the keyboard.

Serial Number _____

THE FCC WANTS YOU TO KNOW

This keyboard complies with the limits for a Class B digital device as specified in Part 15 of *FCC Rules*. These limits provide reasonable protection against radio and TV interference in a residential area. However, your keyboard might cause TV or radio interference even when it is operating properly. To eliminate interference, you can try one or more of the following corrective measures:

- Reorient or relocate the receiving antenna.
- Increase the distance between the keyboard and the radio or TV.
- Use outlets on different electrical circuits for the keyboard and the radio or TV.

Consult your local RadioShack store if the problem still exists.

You must use shielded interface cables with this equipment.

© 1999 Tandy Corporation.
All Rights Reserved.

Optimus, RadioShack, and Adaptaplug are registered trademarks used by Tandy Corporation.

FEATURES

Your Optimus MD-1150 Electronic Keyboard is a state-of-the-art keyboard with many exciting features. You can set the keyboard to sound like 100 different musical instruments or sound effects. To accompany your music, the keyboard has 100 rhythms, as well as auto accompaniments and percussion sounds.

Your keyboard also includes a MIDI (Musical Instrument Digital Interface) feature, which lets you connect it to other MIDI-equipped musical instruments or devices, even your personal computer.

This versatile keyboard can provide hours of fun and is ideal for anyone who wants to make music, from the beginner to the experienced musician.

Note: The MD-1150 conforms to most, but not all, General MIDI specifications. Because of this, you might experience some incompatibility when using the MD-1150 with another General MIDI device. For more information, see "Using MIDI" on Page 25.

Your keyboard's features include:

61 Full-Size Keys with Touch Response — the keyboard's volume varies in response to the force of your touch, just like an acoustic piano or organ, so you can add emotion to your music.

Backlit Liquid Crystal Display — shows the notes and chords as you play them, along with the current tone, rhythm, and tempo. The built-in backlight makes it easy to read the display even in darkness.

16-Note Polyphonic Sound — lets you play and hear up to 16 notes at the same time so you can play or create almost any type of music.

100 Tones — you can set your keyboard to sound like anything from a harpsichord to a honky-tonk piano.

100 Prerecorded Tunes — let you hear a sample of what you and the keyboard can do. You can play the tunes either one at a time or consecutively, and you can turn off the melody or accompaniment portion so you can play along with the tunes.

100 Auto-Rhythms — give you a steady beat for many styles of music, from rhumba to slow rock.

Transpose Function — lets you instantly change the key of the music, even while you are playing.

Headphones/Output Jack — lets you connect headphones so you can play without disturbing others, or an external amplifier so you can play for a crowd.

Sustain Jack — lets you connect a sustain pedal (not supplied) to the MD-1150 so you can sustain your keyboard's sound.



Tempo Control — lets you speed up or slow down the tempo of any selected music pattern.

- This Owner's Manual explains how to use this electronic keyboard. It does not teach music.

Tune Control — lets you adjust the pitch of your keyboard so you can play in tune with other instruments.

Fill-In Rhythm — lets you insert a short variation into any auto-rhythm.

Auto Accompaniment — lets you automatically play a preset harmonic pattern to match the selected auto-rhythm.

Chord Book — lets you easily see which keys to press and which fingers to use to form a chord, as well as easily learn the chord's name.

Two Built-In Speakers — provide excellent sound to help make your music come alive.

Power Options — let you power the keyboard from internal batteries (not supplied) or standard AC power (with an optional adapter) so you can make music almost anywhere.

Notes:

- If the keyboard is left in one place for a very long time, its feet could mar your furniture's finish. We recommend you place the feet on felt cloth pads to protect your furniture or use an optional keyboard stand, available at your local RadioShack store.

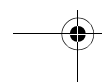
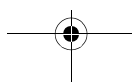
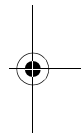
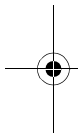

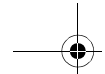

CONTENTS

Preparation	7
Connecting Power	7
Using Batteries	7
Using AC Power	8
Connecting Headphones	8
Listening Safely	8
Connecting an External Amplifier	9
Using the Music Stand	9
Operation	10
Basic Operation	10
Cancelling Auto Power Off	11
Playing the Prerecorded Tunes	11
Playing Back a Prerecorded Tune	11
Playing Along with a Prerecorded Tune	13
Turning Applause Off/On	13
Consecutively Playing Back the Tunes	13
Using the Preset Tones	13
Selecting/Playing a Preset Tone	14
Keyboard Split Tones	14
Percussion Sounds	15
Layered Tones	15
Using the Preset Auto-Rhythms	15
Selecting/Playing an Auto-Rhythm	16
Using SYNCHRO	17
Using FILL-IN	17
Using Auto Accompaniment	17
Adjusting the Accompaniment Volume	18
Concert Chord	18
Standard Fingering	20
Using the Chord Book	21
Special Features	23
Changing Keys	23
Tuning the Keyboard	23
Using Touch Response	24
Using a Sustain Pedal	24

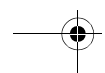
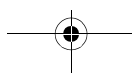



Using MIDI	25
About MIDI	25
Making the MIDI Connections	25
MIDI Data	26
Changing MIDI Settings	27
Notes About the MIDI Implementation Chart	28
Troubleshooting	29
Standard Fingering Chord Charts	31
Note Table	34
MIDI Implementation Chart	35
Care and Maintenance	37
Specifications	38

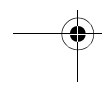
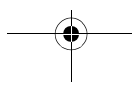
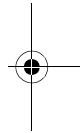
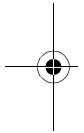

PREPARATION

Note: To connect a MIDI device, see “Making the MIDI Connections” on Page 25. To connect a sustain pedal, see “Using a Sustain Pedal” on Page 24.

CONNECTING POWER

You can power your MD-1150 from either:

- internal batteries (see “Using Batteries”)
- standard AC power using an optional AC adapter (see “Using AC Power” on Page 8)

Notes:

- Connecting an AC adapter automatically disconnects internal batteries.
- Always disconnect the adapter when you finish using the MD-1150.

Using Batteries

Your MD-1150 can use six D batteries (not supplied) for power. For the best performance and longest life, we recommend RadioShack alkaline batteries.

Cautions:

- Use only fresh batteries of the required size and recommended type.

- If you do not plan to use the MD-1150 with batteries for a week or more, or if you will be using only AC power, remove the batteries.
- Do not mix old and new batteries, different types of batteries (standard, alkaline, or rechargeable), or rechargeable batteries of different capacities.

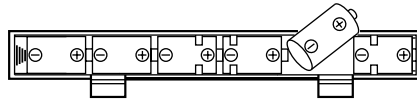

1. Press the tabs on the battery compartment cover, then pull up to remove the cover.
2. Put the batteries in the compartment as indicated by the polarity symbols (+ and -) marked beside the compartment.
3. Replace the cover.

If the MD-1150 sounds weak or does not work properly, replace all six batteries.

Warning: Dispose of old batteries promptly and properly. Do not burn or bury them.

Caution: Always remove old or weak batteries; batteries can leak chemicals that can destroy electronic parts.

Using AC Power

You can power your MD-1150 from standard AC power using a 9-volt AC adapter (not supplied) and a Size M Adaptaplug .

Cautions:



You must use an AC adapter that supplies 9 volts and delivers at least 800 milliamps. Its center tip must be set to negative, and its plug must correctly fit the MD-1150's **DC 9V** jack. Using an adapter that does not meet these specifications could damage the MD-1150 or the adapter.

- Always press **POWER** to turn off the keyboard before you connect or disconnect the adapter.
- Always plug the AC adapter into the MD-1150 before you plug it into the AC outlet. Always unplug the AC adapter from the AC outlet before you unplug it from the MD-1150.

Follow these steps to power your MD-1150 from AC power.

1. Insert the adapter's barrel plug into the **DC 9V** jack on the back of the MD-1150.
2. Plug the adapter into a standard AC outlet.

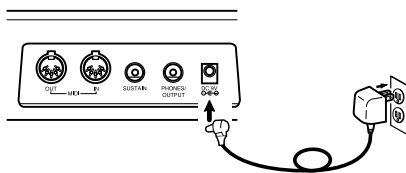

CONNECTING HEADPHONES

To listen to your MD-1150 without disturbing others, you can connect a pair of 1/4-inch (6.35-mm) plug stereo headphones (not supplied). Your local RadioShack store sells a wide selection of headphones.

To connect a pair of headphones, insert the headphones' plug into the **PHONES/OUTPUT** jack on the back of the keyboard.

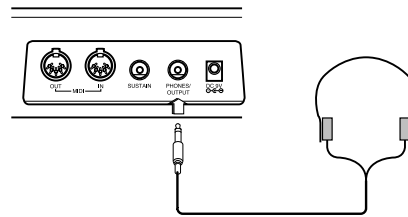

Note: Connecting headphones disconnects the MD-1150's built-in speakers.

Listening Safely

To protect your hearing, follow these guidelines when you use headphones.

- Set the volume to the lowest setting before you begin listening. After you begin listening, adjust the volume to a comfortable level.
- Do not listen at extremely high volume levels. Extended high-volume listening can lead to permanent hearing loss.

- Once you set the volume, do not increase it. Over time, your ears adapt to the volume level, so a volume level that does not cause discomfort might still damage your hearing.

CONNECTING AN EXTERNAL AMPLIFIER

To amplify your MD-1150's sound, you can connect it to an external amplifier (not supplied) using an audio cable (not supplied) with a 1/4-inch (6.35-mm) plug.

To connect an external amplifier to your keyboard, insert the cable's 1/4-inch (6.35-mm) plug into the **PHONES/OUTPUT** jack on the back of the keyboard, and connect the cable's other end to the amplifier's input jack(s) (such as AUX IN or TAPE IN).

Your local RadioShack store sells a full line of amplifiers, speakers, and connection cables.

USING THE MUSIC STAND

To easily view sheet music while playing your keyboard, insert the supplied music stand into the slot on the top back panel.

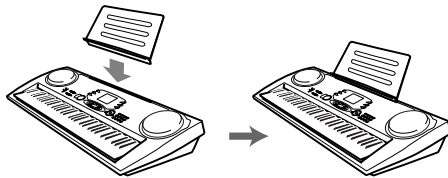

OPERATION

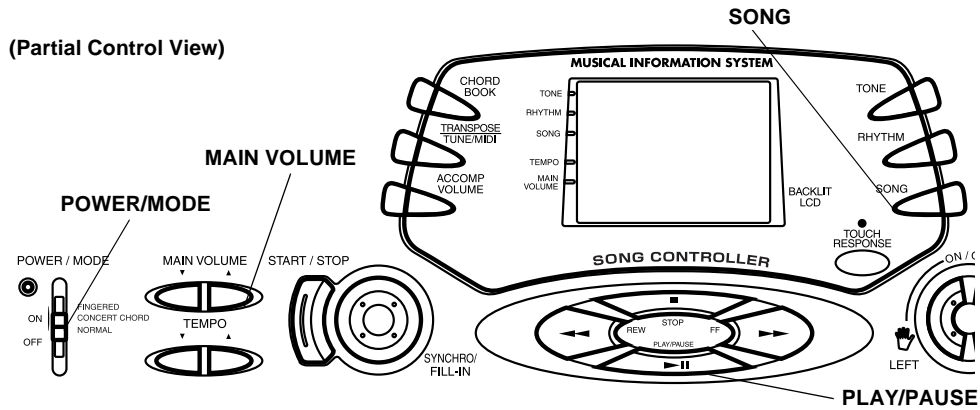

BASIC OPERATION

1. To turn on the keyboard, set **POWER/MODE** to **NORMAL**. The **POWER/MODE** indicator and the display light.

Note: To save power when operating on batteries, the keyboard automatically turns off after about 6 minutes if you do not press a key. To turn on the keyboard again, set **POWER/MODE** to **OFF** then back to **NORMAL**.

2. To hear a sample of the MD-1150's many sounds, play a prerecorded tune (see "Playing the Prerecorded Tunes" on Page 11). To make your own music, simply begin playing the keyboard.

Notes:

- The keyboard automatically selects the tone PIANO 1 (No. 00) when you turn the power on. To select a different tone, see "Selecting/Playing a Preset Tone" on Page 14.

- To select an auto-rhythm, see "Using the Preset Auto-Rhythms" on Page 15.
 - To play auto accompaniment, see "Using Auto Accompaniment" on Page 17.
3. Repeatedly press **MAIN VOLUME ▲** or **▼** to increase or decrease the volume. The current setting appears.

Notes:

- The keyboard's volume ranges from 0 (no sound) to 9 (maximum). Each time you turn on the keyboard, the volume is set to 7.
- To quickly change the volume setting, hold down **MAIN VOLUME ▲** or **▼**.
- To quickly return to the default volume setting of 7, press both **MAIN VOLUME** buttons at the same time.
- The volume level differs depending on the tone, accompaniment, or song you selected.

- To turn off the keyboard, set **POWER/MODE** to **OFF**. The **POWER/MODE** indicator and the display turn off.

Canceling Auto Power Off

To have the keyboard not automatically turn off during a session, turn on the keyboard while holding down **TONE**.

The next time you turn the keyboard off then back on again, it will automatically turn off after about 6 minutes.

PLAYING THE PRERECORDED TUNES

You can listen to any of the 100 tunes that come prerecorded in the keyboard, or you can turn off a tune's melody or accompaniment and play along on the keyboard.

Playing Back a Prerecorded Tune

- Press **SONG**. An indicator appears next to **SONG** on the display and the number of the current tune appears.

Note: The keyboard always selects the tune "(Everything I Do) I Do It for You" (No. 00) the first time you press **SONG** after turning the power on.

- Choose a tune from the 100 **SONGS** list and enter its two-digit number on the keypad.

Or, you can press **+** or **-** to move to the next higher or lower numbered tune.

Notes:

- Precede a single-digit number with a 0. For example, to select 08 ("Killing Me Softly with His Song") press **0 8**.
 - If you enter an incorrect first digit, press **SONG** to clear your entry, then enter the correct digit.
- Press **PLAY/PAUSE** to start playing the tune.

You can change the tune by repeating Step 2 even while a tune is playing. The new tune immediately begins to play.

As a tune plays, the display shows:

- a "score" to show you the notes that are playing (right side of the display)
- a "keyboard" to show you the fingering and which keys are pressed (bottom of the display)
- a "metronome" to show you the selected tempo — the metronome's bar swings along with the tempo you selected, and the black dots above the metronome show the beat count in the measure
- the chord name (except for tunes 70 to 99) to the center right of the display
- "play" indicator (▶) to the upper left of the display

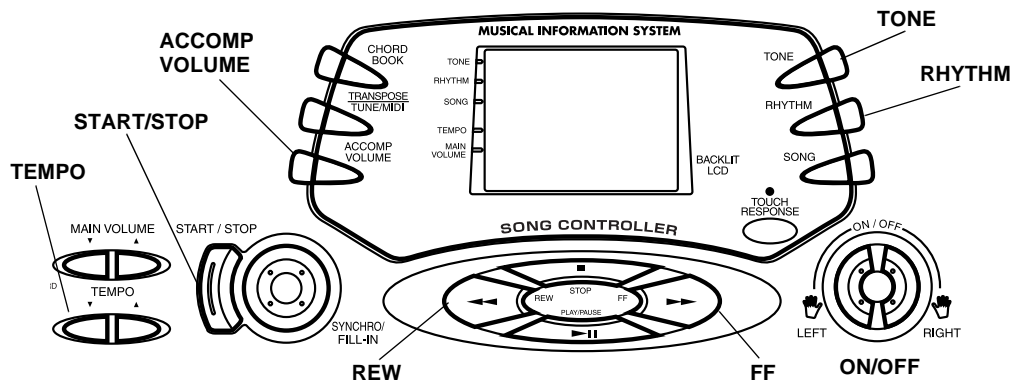

Note: Each tune plays a different preset tone for the melody, but you can change to another tone even while the tune is playing. Follow the steps under “Selecting/Playing a Preset Tone” on Page 14 to select a different tone.

- Use **MAIN VOLUME** to adjust the overall volume as desired.

To adjust only the accompaniment volume (except tunes 70 to 99), press **ACCOMP VOLUME** then enter the desired volume level using the number keys (between 0 and 9) or press + or – within 5 seconds.

- To move to a particular section of a tune, hold down **REW** or **FF** during play. The indicator (◀◀ or ▶▶) appears along with the play indicator (▶). The keyboard sounds a beep for each measure. When you reach the section you want, release **REW** or **FF** to resume play.

Hint: You can find the scores for most of the prerecorded tunes in the *Sheet Music and Play Guide for the*

Prerecorded Tunes, supplied with your MD-1150. Refer to this sheet to count the number of measures to skip.

To change the tempo, press **TEMPO** ▲ or ▼. The current tempo setting appears.

Notes:

- To quickly slow down or speed up the tempo, hold down **TEMPO** ▲ or ▼.
 - To reset the tempo to its default (original) speed, press **TEMPO** ▲ or ▼ at the same time.
 - Tunes 70 to 99 are arranged so the tempo changes during play. However, if you select a tempo other than the one you previously selected, those tunes play in the newest tempo.
- To temporarily stop playing the tune, press **PLAY/PAUSE** again. || appears. To stop the tune completely, press **STOP**.

Playing Along with a Prerecorded Tune

Follow these steps to have the keyboard not play the melody of a prerecorded tune, so you can!

1. Select and enter the number of the tune you want to play.
2. Press **ON/OFF RIGHT** to turn off the melody. Press **ON/OFF LEFT** to turn off the accompaniment.

Notes:

- Tunes 70 to 99 are piano solo tunes. You can turn off either the right-hand or left-hand portion, but not both.
 - If you select tunes 00 through 69 and turn off both the melody and accompaniment, the keyboard plays an obbligato (a simple background accompaniment).
3. Press **PLAY/PAUSE** to start play.
 4. Adjust the tempo and volume as desired.
 5. Play along with the tune on the keyboard.

Note: You can turn the melody on or off by repeating Step 2 even while the current tune is playing.

6. The tune you selected plays continuously until you press **STOP**. To temporarily stop the tune, press **PLAY/PAUSE** again. To stop the tune completely, press **STOP**.

Turning Applause Off/On

When you turn off either the melody or the accompaniment and then play a tune, applause automatically sounds at the end of the tune. To turn off the applause, hold down **STOP** and press either **ON/ OFF LEFT** or **ON/OFF RIGHT**. **Ap1s=Off** appears. To turn the applause on again, press the same buttons. **Ap1s=On** appears.

Consecutively Playing Back the Tunes

To have the keyboard play all 100 prerecorded tunes consecutively, press either **TONE** or **RHYTHM**, then press **PLAY/PAUSE**. The keyboard plays the tunes in sequence starting with Tune 00.

To stop consecutive playback, press **STOP** or **START/STOP**.

USING THE PRESET TONES

Your keyboard can sound like 100 different musical instruments or sound effects. The name and two-digit number for each preset tone is listed on the 100 TONES list on the keyboard's top panel.

Notes:

- The keyboard has 16-note (maximum) polyphonic sound. This means that you can play up to 16 different notes at the same time with most of the keyboard's preset tones. Some of the keyboard's preset tones, however, are capable of only 8-note polyphony.
- Most tones on this keyboard have been recorded and processed using a technique called digital sampling. To ensure a high level of tonal quality, samples are taken in the low, mid, and high ranges and are then combined to sound amazingly close to the originals. You might notice very slight differences in volume or sound quality for some tones when you play them at different positions on the keyboard. This is an unavoidable result of multiple sampling and is not a malfunction.
- Some sound effect tones, such as PERCUSSION (No. 99), do not follow the musical scale when played, but change effect as you play them in different octaves on the keyboard.

Selecting/Playing a Preset Tone

1. Press **TONE**. **TONE** and the current tone's number appears.

Note: Each time you turn the keyboard on, it automatically selects the tone PIANO 1 (No. 00).

2. To play a different tone, choose a preset tone from the 100 TONES list and enter its two-digit number on the keypad. As you press the keys, the selected digits appear.

Or, you can use **+** or **-** to move to the next higher or lower numbered tone.

Notes:

- Precede a single-digit number with a 0. For example, to select ELEC PIANO 1 (No. 04), press **04**.
 - If you enter an incorrect first digit, press **TONE** to clear your entry, then enter the correct digit.
3. Play the keyboard to hear the selected tone and adjust **MAIN VOLUME** to the desired level.
 4. To select a different tone, repeat Steps 1 and 2.

Keyboard Split Tones

The preset tones numbered 90 through 96 on your keyboard let you automatically play two different musical instruments or sound effects independently on opposite sides of the keyboard.

The instrument listed first in the tone's name plays on the left half of the keyboard (below middle C). The instrument listed next plays on the right half of the keyboard (above middle C). For example, BS/PNO (No. 90) plays a bass tone on the left half of the keyboard and a piano tone on the right.

Percussion Sounds

PERCUSSION (No. 99) lets you play the 39 different percussion sounds shown here. The symbol for each sound appears above the corresponding key on the keyboard.

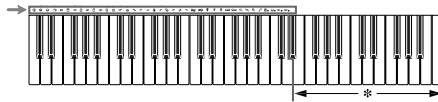

Note: When you select the Fingered or Concert Chord mode, the keys in the lower 1¹/₂ octaves become the accompaniment keys and do not produce percussion sounds. See "Using Auto Accompaniment" on Page 17.

BASS DRUM 1	OPEN HI-HAT	COWBELL	LOW TIMBALE
SIDE STICK	LOW-MID TOM	CRASH CYMBAL 2	HIGH AGOGO
ACOUSTIC SNARE	HIGH-MID TOM	CLAVES	LOW AGOGO
HAND CLAP	CRASH CYMBAL 1	RIDE CYMBAL 2	CABASA
ELECTRIC SNARE	HIGH TOM	HIGH BONGO	MARACAS
LOW FLOOR TOM	RIDE CYMBAL 1	LOW BONGO	VOICE BASS DRUM
CLOSED HI-HAT	CHINESE CYMBAL	MUTE HIGH CONGA	VOICE SNARE
HIGH FLOOR TOM	RIDE BELL	OPEN HIGH CONGA	VOICE CLOSED HI-HAT
PEDAL HI-HAT	TAMBOURINE	LOW CONGA	VOICE OPEN HI-HAT
LOW TOM	SPLASH CYMBAL	HIGH TIMBALE	

Layered Tones

The preset tones numbered 80 through 89 on your keyboard let you automatically play two different layered tones at the same time when you press one key. For example, STR PNO (No. 80) plays string and piano tones when you press a key.

USING THE PRESET AUTO-RHYTHMS

Your keyboard has 100 preset auto-rhythms that provide a steady beat for your music. The name and two-digit number of each preset auto-rhythm is listed on the keyboard's top panel.

You can play a preset auto-rhythm on the keyboard in any of the following ways:

- select and play a rhythm (see "Selecting/Playing an Auto-Rhythm")
- synchronize the start of a rhythm with your music (see "Using SYNCHRO" on Page 17)
- briefly vary the pattern of a rhythm (see "Using FILL-IN" on Page 17)

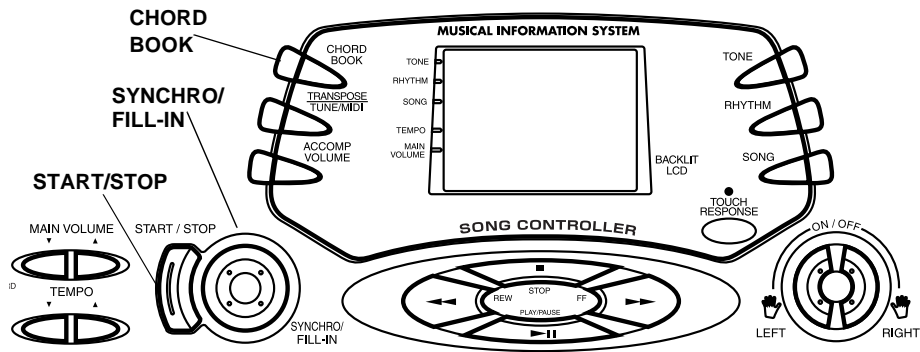

Selecting/Playing an Auto-Rhythm

1. Press **RHYTHM**. An indicator appears to the right of **RHYTHM** and the number of the current auto-rhythm appears.

Note: Each time you turn on the keyboard, it automatically selects the rhythm Funky Pop 1 (No. 00).

2. To select a different rhythm, choose an auto-rhythm from the 100 RHYTHMS list and enter its two-digit number on the keypad. Or, repeatedly press **+** or **-** to move to the next higher or lower numbered rhythm.

Notes:

- Precede a single-digit number with a 0. For example, press **0 9** to select POP BALLAD (No. 09).
- If you incorrectly enter the first digit of the rhythm, press **RHYTHM** to clear the entry and return to the last selected auto-rhythm.

3. Press **START/STOP** to start the selected auto-rhythm.

4. Adjust **MAIN VOLUME** and **ACCOMP VOLUME** to the desired level (see "Adjusting the Accompaniment Volume" on Page 18).

5. To change the auto-rhythm speed, press **TEMPO** **▲** or **▼**. The current tempo setting appears.

Notes:

- You can adjust the tempo to play an auto-rhythm from 20 to 255 beats per minute.
- To quickly slow down or speed up the tempo, hold down **TEMPO** **▲** or **▼**.
- To reset the tempo to its default (original) speed, press **TEMPO** **▲** and **▼** at the same time.

6. Play the keyboard along with the auto-rhythm.

7. To select a different rhythm, repeat Steps 1 through 3.

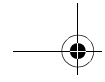

8. To stop the auto-rhythm, press **START/STOP** again.

Using **SYNCHRO**

This feature lets you synchronize the start of an auto-rhythm with the beginning of your music.

After you select and enter an auto-rhythm, press **SYNCHRO/FILL-IN**. The bars of the metronome flash on the display to show the keyboard is in a standby mode.

Begin playing the keyboard. The keyboard automatically begins to play the rhythm when you press any key within the first 1½ octaves of the lower end of the keyboard (the first 18 keys from the left side of the keyboard).

Using **FILL-IN**

This feature lets you insert a short (1- to 2-measure) variation in the beat pattern of a selected auto-rhythm.

Simply press **SYNCHRO/FILL-IN** while the auto-rhythm is playing. The keyboard inserts a 1- to 2-measure variation, then the original rhythm automatically resumes at the end of the current measure.

USING AUTO ACCOMPANIMENT

The 18 keys with note labels above them on the left side of the keyboard are called accompaniment keys.

You can set the keyboard to play two different types of auto accompaniment using the accompaniment keys.

- **Concert Chord** — lets you play chords on the accompaniment keys using chord formations of from one to four notes. The number of keys you press determines the type of chord that plays (see “Concert Chord” on Page 18).
- **Standard Fingering** — lets you play chords on the accompaniment keys using standard chord formations of three or four notes (see “Standard Fingering” on Page 20).

Notes:

- You can use the keyboard’s rhythm controls (**FILL-IN** and **SYNCHRO**) with both types of auto accompaniment.
- After you press the auto accompaniment keys, the keyboard plays the same chord until you press other keys to play a different chord or press **START/STOP**.

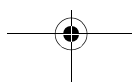
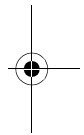
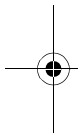

Adjusting the Accompaniment Volume

The MD-1150 lets you adjust the volume of your accompaniment separately from the overall volume of the keyboard.

1. Press **ACCOMP VOLUME**. The current accompaniment volume setting appears on the display next to **Acomp Vol.**
2. Within 5 seconds, enter a number from 0 (no sound) to 9 (loudest) on the keypad. The number appears on the display as you press the key.

Or, press **-** or **+** to select the next lowest or highest accompaniment volume setting.

To reset the accompaniment volume to its default value of 7, press **-** and **+** at the same time.

Note: You can adjust the accompaniment volume separately for your keyboard play and prerecorded tune playback.

Concert Chord

The concert chord method lets beginning keyboard players easily select and play a chord.

The number of accompaniment keys you press determines the type of chord that plays. This chart shows the chord type that plays when you press one,

two, three, or four accompaniment keys at the same time.

Number of Keys Pressed	Chord Type
<p>C D E F G A B C D E F</p>	Major
<p>C D E F G A B C D E F</p>	Minor (m)
<p>C D E F G A B C D E F</p>	Dominant Seventh (7)
<p>C D E F G A B C D E F</p>	Minor Seventh (m7)

The lowest note you play determines the key of the chord. For example, if the lowest note is C, the keyboard plays a C chord.

Note: You can press any labeled note(s) to the right of the lowest note in the chord to produce a minor, a dominant seventh, or minor seventh chord.



Follow these steps to start concert chord auto accompaniment.

1. Set **POWER/MODE** to **CONCERT CHORD**.
2. Enter a two-digit auto-rhythm number.
3. To start the auto-rhythm before the auto accompaniment, press **START/STOP**.

Or, to synchronize the start of the selected auto-rhythm with your accompaniment, press **SYNCHRO/FILL-IN**.

4. Begin the accompaniment at the desired interval by pressing the desired accompaniment key(s).

To play a melody along with the accompaniment, press any key(s) to the right of the accompaniment keys.



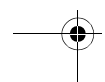
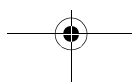
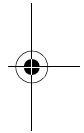
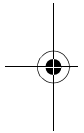





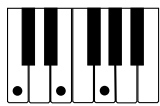
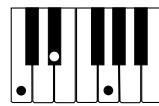
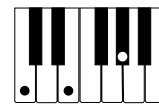
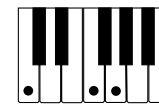

5. Adjust the tempo, **MAIN VOLUME**, and **ACCOMP VOLUME** to the desired levels.
6. To change chords without interrupting the rhythm, simply press the auto accompaniment key(s) required to form the new chord.
7. To stop auto accompaniment and the auto-rhythm, press **START/STOP**.

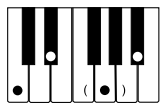

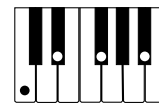
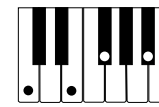
Standard Fingering

The standard fingering method uses standard formations of three or four notes, and lets the experienced musician play a wider variety of accompaniment chords.

This chart shows the 15 chord types you can play on your keyboard by using standard fingering.

 Major (M)	 Minor (m)	 Augmented (aug)	 Suspended 4th (sus4)	 Dominant 7th (7)
 Minor 7th (m7)	 Major 7th (M7)	 Minor Half-Diminished (m7 ⁵)	 Major Half-Diminished (7 ⁵)	 Dominant Suspended 4th (7sus4)
 Major 9th (add9)	 Minor 9th (madd9)	 Minor/Major 7th (mM7)	 Diminished	 Diminished 7th (dim7)

Notes:

- You do not have to press the key marked with parentheses on the keyboard in the preceding chart to produce a 7, m7, M7, mM7, 9, or m9 chord.
- This chart shows only one possible fingering position for each chord. It is possible to play a chord using several different positions. For example, the following three fingering positions produce the same C chord.

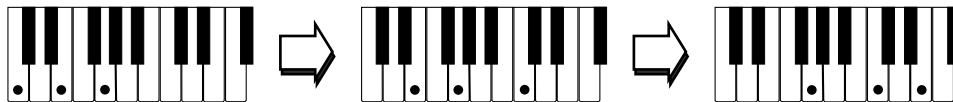

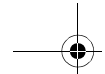

- When you play an aug, 7–5, or dim7 chord, the lowest note you play determines the root of the chord. Be sure that your fingering correctly defines the root you want.

Note: See “Standard Fingering Chord Charts” on Page 31 for a list of all the chords you can play on your keyboard using standard fingering accompaniment.

Follow these steps to start standard fingering auto accompaniment.

1. Set **POWER/MODE** to **FINGERED**.
2. Select and enter an auto-rhythm.
3. To start the auto-rhythm before your auto accompaniment, press **START/STOP**.

Or, to synchronize the start of the selected auto-rhythm with your accompaniment, press **SYNCHRO/FILL-IN**.

4. Begin the accompaniment at the desired interval by pressing at least three accompaniment keys to play the desired chord.

To play a melody along with the accompaniment, press any key(s) to the right of the accompaniment keys.

5. Adjust the tempo, **MAIN VOLUME**, and **ACCOMP VOLUME** to the desired levels.
6. To change chords without interrupting the rhythm, simply press the auto accompaniment keys required to form the new chord.

7. To stop auto accompaniment and the auto-rhythm, press **START/STOP**.

USING THE CHORD BOOK

You can use your keyboard’s chord book display feature to see which keys to press and which fingers to use to form a chord. You can also display the name of a chord you play.

Follow these steps to display and sound a chord.

1. Press **CHORD BOOK**.
2. Press **CLEAR (0)** to clear any previous chord entry.
3. If you want to see information about a major chord while you play it, skip to Step 4. Otherwise (if the desired chord name is a minor chord), enter the chord’s name using that chord’s keys on the numeric keypad.

For example, to enter a minor 7–5 chord, press **m (8) 7 (9) –5 (2)**. Or, to enter 7sus4, press **7 (9)** and **sus4 (1)**.

4. Press the root key on the accompaniment keyboard to play the chord. For example, to play an F# chord, press the **F#** key.

As the chord plays, the display shows:

- the chord you entered
- the keys to press to form the chord (on the bottom “keyboard”)

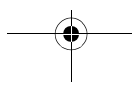
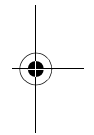
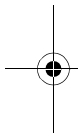



- the fingers you need to use to play the chord (on the center “hands”)
 - the notes that make up the chord (on the staff display)
5. Use – or + to scroll through the chords associated with the root chord you entered in Step 3. Or, press a different root key to see the chords based on that key.

Notes:

- If the chord is not recognized by the keyboard, only a dash appears on the display.
 - Since the keyboard automatically changes some chords so you can play them on the accompaniment keyboard, the keyboard might display some chords in inverted form.
6. Using the center “hands” as a guide, play the displayed chord on the keyboard.
7. When you have finished, press **CHORD BOOK** to turn off chord book.

To display the name of the chord you play, press **CHORD BOOK**, then play the chord on the accompaniment keyboard. The display shows the chord name and other information.

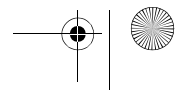
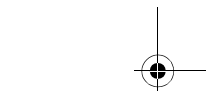
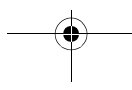
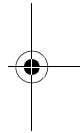
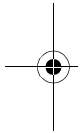

SPECIAL FEATURES

CHANGING KEYS

The keyboard automatically selects the key of middle C each time you turn it on.

For added flexibility as you play, the keyboard lets you change (transpose) the musical key in which it plays.

Note: You cannot change the key while a prerecorded tune is selected or playing.

1. Repeatedly press **TRANPOSE/TUNE/MIDI** until **Trans** and the current key setting appear.

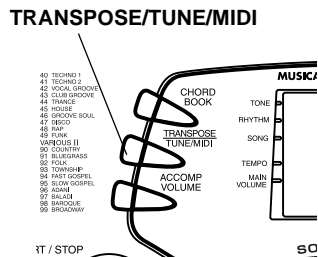

Note: The number on the display is the number of “semitones” to which the keyboard is set, compared to its default key. A semitone is a measurement that represents the acoustical interval between the tones of any two keys on the keyboard.

For example, the difference between C and C# or B and B# is one semitone. You can transpose the key down 6 semitones (to an F#) and up 5 semitones (to an F) — a full octave.

2. Within 5 seconds, press **-** or **+** to lower or raise the key. Each time you press **-** or **+**, the number on the

display decreases or increases by 1 (semitone).

As you raise the key, 1 is C#, 2 is D, and so on. As you lower the key, -1 is B, -2 is A#, -3 is A, and so on.

Notes:

- You can also use the number keypad to quickly raise the key. Simply press the semitone change value (1 to 5).
- The keyboard automatically resets the key to the default value of 0 (middle C) each time you play a prerecorded tune.
- Each preset tone plays within a specified range. If a key change causes a note to exceed its range, the same note sounds in the nearest octave.
- When you select preset tones 96 through 99 after changing the key, the keyboard split point changes accordingly (see “Keyboard Split Tones” on Page 14).
- Changing the key does not affect the PERCUSSION (No. 99) preset tone.

TUNING THE KEYBOARD

Although your keyboard never goes out of tune, it does let you adjust its pitch to match other instruments or musical recordings.



Note: You cannot tune the keyboard while a prerecorded tune is displayed or playing.

Follow these steps to tune the keyboard.

1. Repeatedly press **TRANPOSE/TUNE/MIDI** until the display shows **Tune** and the current pitch setting.

Note: The number on the display is the number of “cents” to which the keyboard is currently tuned, compared to its default pitch. A cent is the measurement that represents the acoustical interval between two tones. 1200 cents equal 1 octave. You can tune the keyboard to within 50 cents (101 levels) of its default pitch.

2. Within 5 seconds, repeatedly press **-** or **+** to lower or raise the keyboard’s pitch. Each time you press the key, the number on the display decreases or increases by 1 (cent).

Notes:

- You can use the number keypad to raise the pitch by entering the cent change value.
- The keyboard automatically resets the tuning pitch to the default value of 00 (cents) each time you turn off the keyboard or play the prerecorded tunes.

USING TOUCH RESPONSE

The MD-1150 has a touch response feature that lets you adjust the volume of your music’s tone based on how hard

you strike the key(s), so you can add emotion to your music.

If you want to turn off this feature, press **TOUCH RESPONSE** so its indicator disappears.

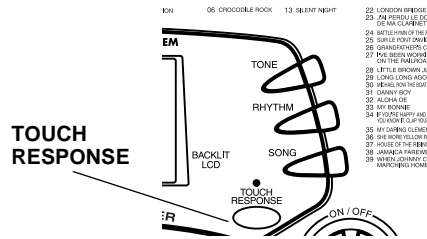

To turn on touch response again, press **TOUCH RESPONSE** so its indicator appears.

Notes:

- The touch response setting does not affect auto accompaniment or received MIDI data.
- The MIDI data sent out from the MD-1150 is affected by the touch response setting.

USING A SUSTAIN PEDAL

For added flexibility and control as you make music, you can connect an optional sustain pedal (not supplied), available through your local RadioShack store. A sustain pedal lets you sustain the keyboard’s sound.

To connect a sustain pedal to your MD-1150, insert the plug on the pedal’s cord into the **SUSTAIN** jack on the back of the keyboard.

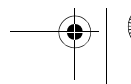
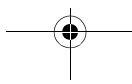

USING MIDI

Your MD-1150 includes a feature called *MIDI* (Musical Instrument Digital Interface). MIDI is the universal standard for sending and receiving performance data between all types of electronic musical instruments, regardless of the manufacturer.

Using MIDI, you can play music on your MD-1150 and another instrument at the same time while pressing the keys on only one, record your music to a sequencer, acquire a wider selection of preset tones from a sound module, and much more.

ABOUT MIDI

Every MIDI-equipped instrument has MIDI OUT and IN terminals, and some also have a MIDI THRU terminal. Each of these terminals serves a different purpose.

MIDI OUT sends MIDI data to (“talks to”) the other MIDI instrument(s).

MIDI IN receives (“listens to”) MIDI data sent by the other MIDI instrument(s).

MIDI THRU lets you connect (“network”) additional MIDI instruments, and sends along to other MIDI devices a copy of all data it receives through its MIDI IN terminal.

Your MD-1150 has **MIDI OUT** and **MIDI IN** terminals.

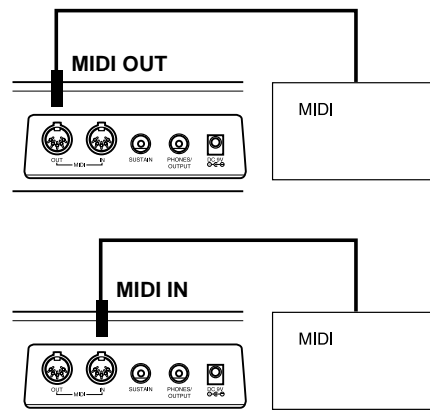

The cable that connects MIDI devices does not actually carry sound between them, like a speaker wire carries sound from a receiver to a speaker. Instead, MIDI-equipped devices communicate with each other using digital codes (instructions). One MIDI device sends digital instructions representing exactly what is being played on it. The other MIDI device receives and translates those instructions, then produces (or records) the sound exactly as it was played on the first device.

MAKING THE MIDI CONNECTIONS

To connect your MD-1150 to another MIDI-equipped device, you must use a MIDI cable, available at your local RadioShack store.

Cautions:

- Always turn off power to your MD-1150 and the other MIDI device before you connect or disconnect MIDI cables.
- As you make the cable connections, be sure to align the MIDI cable pins with the matching holes on your keyboard's **MIDI OUT** and **MIDI IN** terminals. If you have trouble plugging in the cable, do not force it! You might damage the plug or the instrument.

To send MIDI data from your keyboard, use a MIDI cable to connect the MD-1150's **MIDI OUT** terminal to the other device's MIDI IN terminal.

To receive MIDI data on your keyboard, use a MIDI cable to connect the MD-1150's **MIDI IN** terminal to the other device's MIDI OUT terminal.

Note: You do not need to make both connections if you are only either sending or receiving.

MIDI DATA

Your MD-1150 can send and receive several different types of MIDI data. The MD-1150's tones, rhythms, and other types of MIDI data are sent automatically as you play.

Notes:

- The MD-1150's prerecorded tunes cannot be sent as MIDI data.

- For detailed specifications of the MIDI function, see the "MIDI Implementation Chart" on Page 34.

Note On/Off — specifies which keys are pressed (Note On) or released (Note Off). Also includes how loud a note is played as a value from 0 to 127.

Notes:

- The pitch of a note depends on the tone that is being used, as shown in the "Note Table" on Page 33.
- If the keyboard receives a "request" to play notes outside of its range (higher or lower), it automatically selects the same note in the nearest octave.

Program Change — specifies the tone. The keyboard sends program change data in the range of 0 to 99, corresponding to tone numbers. It receives data within the same range if GM tone mapping is set to N, or in the range of 0 to 127 if GM tone mapping is set to G. In the latter case, tones in the range of 100 to 127 are translated to the closest tone that the keyboard has.

Pitch Bend — supplies pitch bend information. The keyboard's pitch changes as it receives a Pitch Bend message through the MIDI IN terminal.

Control Change — adds effects such as vibrato and volume changes applied during keyboard play. The message includes a control number (the effect type) and a control value (the on/off and depth of the effect).

Here is the data that can be received with this keyboard and the corresponding control number.

Effect	Control Number
Modulation	1
Volume	7
Pan	10
Hold1 (Sustain)	64

The MD-1150 can send Hold1 Control Change data only when you connect a sustain pedal and press it.

CHANGING MIDI SETTINGS

The MD-1150 lets you change two MIDI parameters, Tone Map and Keyboard Channel.

Keyboard Channel — sets the channel for sending MIDI data to an external device (Default: 01). The MD-1150 receives MIDI data on channels 1 through 4 and 10 only. The data received on other channels are ignored. For transmission of MIDI data, you can use any of 16 channels.

1. Repeatedly press **TRANPOSE/TUNE/MIDI** until **Keybd Ch** appears.
2. Within 5 seconds, press – or + to select the channel you want.

Tone Map — sets the range of program change values received/recognized by this keyboard.

1. Repeatedly press **TRANPOSE/TUNE/MIDI** until **TonMap=N** appears.
2. Within 5 seconds, press – or + to select the setting you want.

N: Normal Tone Map. This setting allows receipt of 0 to 99 program changes. Each program change corresponds to one of the keyboard's prerecorded tones.

G: General MIDI Tone Map. This setting allows receipt of all 0 to 127 program changes. Any data over 100 are translated to the closest tone the MD-1150 has. See "Note Table" on Page 33 for details.

Select G when you listen to General MIDI data from an external device.

NOTES ABOUT THE MIDI IMPLEMENTATION CHART

The “MIDI Implementation Chart” on Page 34 illustrates the details of the keyboard’s MIDI function. An O in the chart means that the keyboard has this feature; an X means it does not have this feature. The following notes explain what the keyboard can do.

Basic Channel — MIDI uses up to 16 channels to exchange data. As in a TV broadcast, different channels send different data. The keyboard can send data in any of 16 channels, but receives data only on channels 1 through 4 or 10.

Mode — The chart shows that Mode 3 is OMNI OFF, POLY. This means the keyboard sends and receives polyphonic data on only one channel at a time.

Note Number — This number represents each key of the keyboard. The lowest number (0) is five octaves below middle C. Since the keyboard’s lowest note is two octaves below middle C and the highest is three octaves above middle C, your keyboard can send note numbers between 36 and 96 and receive note numbers from 0 through 127. The keyboard automatically assigns any key outside its range to a key within its key range.

Velocity — This number shows how fast the key was pressed, or how loud the note should sound. Pianissimo (1) is the lowest velocity, Fortissimo (127) is

the loudest. A zero (0) means the key is released. Your keyboard can send and receive all volume levels from 0 through 127.

9n — This means that the Note On message is 9 hexadecimal, and n is the channel number.

Pitch Bender — The keyboard receives (but cannot send) pitch bending signals.

Control Change — This feature sends data on various controllers, each having its own number. For the details of each parameter, see “MIDI Data” on Page 26.

Program Change — This feature changes the preset sounds. Each sound number corresponds to a program number between 0 and 127. For more information, see “MIDI Data” on Page 26.

TROUBLESHOOTING

If your MD-1150 is not performing as it should, these suggestions might help. If you still cannot solve the problem, take the keyboard to your local RadioShack store for assistance.

Trouble	Possible Cause	Remedy
No sound, even if keys are pressed.	The keyboard has turned off automatically.	Set POWER/MODE to OFF then ON again.
	Volume is turned down.	Repeatedly press MAIN VOLUME ▲ to increase the volume.
	Headphones are connected.	Disconnect headphones.
	Power supply problem.	Check the power supply. <ul style="list-style-type: none"> • Are battery symbols (+/-) facing correctly? • Are the batteries fresh? • Is the AC adapter connected properly?
	You are pressing too few accompaniment keys while POWER/MODE is set to FINGERED .	Set POWER/MODE to NORMAL or CONCERT CHORD . Press 3 or 4 keys to form a chord while POWER/MODE is set to FINGERED .
No sound when connected to an external amplifier.	Volume is turned down.	Repeatedly press MAIN VOLUME ▲ to increase the volume.
	Defective connection cord.	Replace the connection cord.
The key or tuning does not match when playing along with another MIDI instrument.	The tuning or transpose parameter is set to a value other than 0 or 00.	Set the tuning or transpose to 0 or 00.
No sound when receiving and playing MIDI data.	MIDI cables are not connected properly.	Check the connection.
Bass notes in General MIDI data are sent out one octave lower.	Tone map parameter is set to N.	Set the tone map parameter to G (see "Changing MIDI Settings" on Page 27).



Trouble	Possible Cause	Remedy
Sounds sent to another MIDI device by the keyboard do not sound correct.	The other device's MIDI THRU function is turned on.	Turn off the MIDI THRU function on the other device.

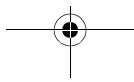

STANDARD FINGERING CHORD CHARTS

These tables show the left-hand fingering for the chords you play most often.

Chord Type Root	M	m	7	m7	dim7	M7	m7-5	dim
C	[5, 3, 1]	[5, 3, 1]	[5, 3, 2, 1]	[5, 3, 2, 1]	[5, 3, 2, 1]	[5, 3, 2, 1]	[5, 3, 2, 1]	[5, 3, 2]
C# (D b)	[5, 3, 1]	[5, 3, 1]	[5, 3, 2, 1]	[5, 3, 2, 1]	[5, 3, 2, 1]	[5, 3, 2, 1]	[5, 3, 2, 1]	[5, 3, 2]
D	[5, 3, 1]	[5, 3, 1]	[5, 3, 2, 1]	[5, 3, 2, 1]	[5, 3, 2, 1]	[5, 3, 2, 1]	[5, 3, 2, 1]	[5, 3, 2]
E b (D #)	[5, 3, 1]	[5, 3, 1]	[5, 3, 2, 1]	[5, 3, 2, 1]	[5, 3, 2, 1]	[5, 3, 2, 1]	[5, 3, 2, 1]	[5, 3, 2]
E	[5, 3, 1]	[5, 3, 1]	[5, 3, 2, 1]	[5, 3, 2, 1]	[5, 3, 2, 1]	[5, 3, 2, 1]	[5, 3, 2, 1]	[5, 3, 2]
F	[5, 3, 1]	[5, 3, 1]	[5, 3, 2, 1]	[5, 3, 2, 1]	[5, 3, 2, 1]	[5, 3, 2, 1]	[5, 3, 2, 1]	[5, 3, 2]
F# (G b)	[5, 3, 1]	[5, 3, 1]	[5, 3, 2, 1]	[5, 3, 2, 1]	[5, 3, 2, 1]	[5, 3, 2, 1]	[5, 3, 2, 1]	[5, 3, 2]
G	[5, 3, 1]	[5, 3, 1]	[5, 3, 2, 1]	[5, 3, 2, 1]	[5, 3, 2, 1]	[5, 3, 2, 1]	[5, 3, 2, 1]	[5, 3, 2]
A b (G #)	[5, 3, 1]	[5, 3, 1]	[5, 4, 2, 1]	[5, 4, 2, 1]	[5, 3, 2, 1]	[5, 4, 2, 1]	[5, 4, 2, 1]	[5, 3, 2]
A	[5, 3, 1]	[5, 3, 1]	[5, 4, 2, 1]	[5, 4, 2, 1]	*	[5, 4, 2, 1]	[5, 4, 2, 1]	[5, 3, 2]
B b (A #)	[5, 3, 1]	[5, 3, 1]	[5, 4, 2, 1]	[5, 4, 2, 1]	*	[5, 4, 2, 1]	[5, 4, 2, 1]	[5, 3, 2]
B	[5, 2, 1]	[5, 2, 1]	[5, 3, 2, 1]	[5, 3, 2, 1]	*	[5, 3, 2, 1]	[5, 4, 2, 1]	[5, 3, 2]

Chord Type Root	aug	sus4	7 sus4	m add9	m M7	7-5	add9
C	[5, 3, 1]	[5, 2, 1]	[5, 3, 2, 1]	[4, 3, 2, 1]	[5, 3, 2, 1]	[5, 3, 2, 1]	[4, 3, 2, 1]
C# (D \flat)	[5, 3, 1]	[5, 2, 1]	[5, 3, 2, 1]	[4, 3, 2, 1]	[5, 3, 2, 1]	[5, 3, 2, 1]	[4, 3, 2, 1]
D	[5, 3, 1]	[5, 2, 1]	[5, 3, 2, 1]	[4, 3, 2, 1]	[5, 3, 2, 1]	[5, 3, 2, 1]	[4, 3, 2, 1]
E \flat (D#)	[5, 3, 1]	[5, 2, 1]	[5, 3, 2, 1]	[4, 3, 2, 1]	[5, 3, 2, 1]	[5, 3, 2, 1]	[4, 3, 2, 1]
E	[5, 3, 1]	[5, 2, 1]	[5, 3, 2, 1]	[4, 3, 2, 1]	[5, 3, 2, 1]	[5, 3, 2, 1]	[4, 3, 2, 1]
F	[5, 3, 1]	[5, 2, 1]	[5, 3, 2, 1]	[4, 3, 2, 1]	[5, 3, 2, 1]	[5, 3, 2, 1]	[4, 3, 2, 1]
F# (G \flat)	[5, 3, 1]	[5, 2, 1]	[5, 3, 2, 1]	[4, 3, 2, 1]	[5, 3, 2, 1]	[5, 3, 2, 1]	[4, 3, 2, 1]
G	[5, 3, 1]	[5, 2, 1]	[5, 3, 2, 1]	[4, 3, 2, 1]	[5, 4, 2, 1]	[5, 3, 2, 1]	[4, 3, 2, 1]
A \flat (G#)	[5, 3, 1]	[5, 2, 1]	[5, 4, 2, 1]	[4, 3, 2, 1]	[5, 4, 2, 1]	[5, 4, 2, 1]	[4, 3, 2, 1]
A	[5, 3, 1]	[5, 2, 1]	[5, 4, 2, 1]	[4, 3, 2, 1]	[5, 4, 2, 1]	[5, 4, 2, 1]	[4, 3, 2, 1]
B \flat (A#)	*	[5, 2, 1]	[5, 4, 2, 1]	[4, 3, 2, 1]	[5, 4, 2, 1]	[5, 4, 2, 1]	[4, 3, 2, 1]
B	*	[5, 2, 1]	[5, 3, 2, 1]	[5, 3, 2, 1]	[5, 3, 2, 1]	[4, 3, 2, 1]	[5, 3, 2, 1]

Note: You cannot play chords marked with an asterisk (*) in the fingered mode on this keyboard.

This illustration shows which fingers on your left hand match the numbers on the chord charts. The illustration also appears on your keyboard's display.

NOTE TABLE

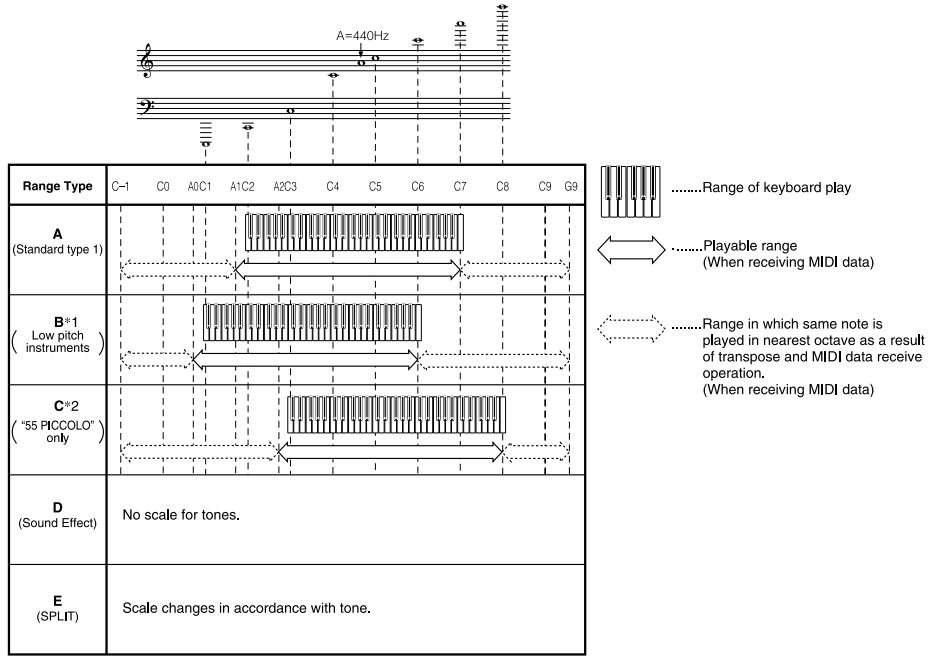

(1)	(2)	(3)	(4)	(1)	(2)	(3)	(4)	(1)	(2)	(3)	(4)	(1)	(2)	(3)	(4)	(1)	(2)	(3)	(4)
00	16	A	000	10	16	A	016	20	16	A	024	30	16	A	040, 041	40	16	A	056
01	16	A	001	11	16	A	017	21	16	A	025	31	16	B	042, 043	41	16	B	058
02	8	A	003	12	16	A	018	22	16	A	026	32	16	A	045, 046, 047	42	8	A	057
03	8	A	002	13	8	A	015	23	16	A	027	33	16	A	048, 055	43	16	B	060
04	16	A	004	14	16	A	014, 019	24	16	A	028	34	16	A	049	44	8	B	059
05	16	A	005	15	8	A	104	25	16	A	029, 030, 031, 084	35	8	A	044	45	16	B	061
06	8	A	008	16	16	A	020	26	16	B	032	36	16	A	050	46	8	B	069
07	8	A	009	17	8	A	021	27	16	B	033, 034, 035	37	8	A	051	47	16	B	062
08	16	A	006	18	16	A	023	28	16	B	036, 037	38	16	A	091, 052	48	8	B	063, 083
09	16	A	007	19	16	A	022	29	16	A	105	39	16	A	053	49	8	B	070

(1)	(2)	(3)	(4)	(1)	(2)	(3)	(4)	(1)	(2)	(3)	(4)	(1)	(2)	(3)	(4)	(1)	(2)	(3)	(4)
50	16	A	064	60	16	A	087	70	8	A	096	80	8	A	106	90	16	E	100, 116
51	16	A	065	61	8	A	081, 086	71	8	A	103	81	8	A	088, 107	91	8	E	117
52	16	A	066, 067	62	16	A	080	72	8	A	097	82	8	A	108	92	16	E	118
53	16	A	068	63	8	A	082	73	8	A	101	83	8	A	109	93	16	E	119
54	16	A	071	64	8	A	089	74	16	B	039	84	8	A	099, 110	94	16	E	120
55	16	C	072	65	8	A	090	75	16	D	126, 127	85	8	A	111	95	16	E	121
56	16	A	073	66	8	A	095	76	8	A	102	86	8	B	112	96	16	E	122
57	16	A	074, 079	67	8	A	092, 093, 098	77	8	D	125	87	8	A	113	97	16	A	010, 011, 014
58	16	A	075, 076, 077	68	8	A	054, 085, 094	78	16	D	124	88	8	A	114	98	16	A	012, 013
59	16	A	078	69	16	B	038	79	8	D	123	89	8	A	115	99	16	D	

Legend:

1. Tone number
2. Maximum polyphony
3. Range type (see "Note Table" on Page 33)
4. Corresponding general MIDI number (see "MIDI Data" on Page 26)

MIDI IMPLEMENTATION CHART

FUNCTION		TRANSMITTED	RECOGNIZED	REMARKS
Basic Channel	Default	1	1-4, 10	
	Changed	1-16	1-4, 10	
Mode	Default	Mode 3	Mode 3	
	Messages Altered	X *****	X *****	
Note Number:	True voice	36-96 *****	0-127 * ₁ 36-96	* ₁ Depends on tone
	Note ON Note OFF	O 9nH v=1-127 X 9nH v=0	O 9nH v=1-127 X 9nH v=0, 8nH v=* ₂	* ₂ No relation
After Touch	Keys	X	X	
	Channels	X	X	
Pitch Bender		X	O	
Control Change	1	X	O	Modulation
	6, 38	X	X	Data entry
	7	X	O	Volume
	10	X	O	Pan
	11	X	X	Expression
	64	O	O	Hold1
	100, 101	X	X	RPN LSB, MSB
	120 121	X X	X X	All sound off Reset all controller
Program Change:	True #	O 0-99 *****	O 0-127* ₃ *****	* ₃ : Depends on GM Tone Map setting When set to N, only the 100 normal list tones from 0 to 99 are received. When set to G, tone numbers 0 to 127 are received. Those that most closely match the 100 prerecorded tones of this keyboard are mapped to the applicable tone numbers (0 to 99)
	Exclusive	X	X	
System Common	: Song Pos	X	X	
	: Song Sel	X	X	
	: Tune	X	X	
System Real Time	: Clock	X	X	
	: Commands	X	X	
Aux Messages	: Local ON/OFF	X	X	
	: All notes OFF	X	X	
	: Active Sense	X	X	
	: Reset	X	X	

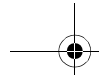

Mode 1: OMNI ON, POLY
Mode 2: OMNI ON, MONO

Mode 3: OMNI OFF, POLY
Mode 4: OMNI OFF, MONO

O: Yes
X: No

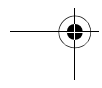
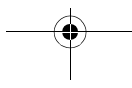
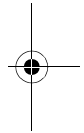
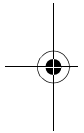

CARE AND MAINTENANCE

Your Optimus MD-1150 Electronic Keyboard is an example of superior design and craftsmanship. The following suggestions will help you care for your keyboard so you can enjoy it for years.



Keep the keyboard dry. If it gets wet, wipe it dry immediately. Liquids might contain minerals that can corrode the electronic circuits.



Use and store the keyboard only in normal temperature environments. Temperature extremes can shorten the life of electronic devices, damage batteries, and distort or melt plastic parts.



Keep the keyboard away from dust and dirt, which can cause premature wear of parts.



Handle the keyboard gently and carefully. Dropping it can damage circuit boards and cases and can cause the keyboard to work improperly.



Use only fresh batteries of the required size and recommended type. Batteries can leak chemicals that damage your keyboard's electronic parts.



Wipe the keyboard with a damp cloth occasionally to keep it looking new. Do not use harsh chemicals, cleaning solvents, or strong detergents to clean the keyboard.

Modifying or tampering with the keyboard's internal components can cause a malfunction and might invalidate its warranty. If your keyboard is not performing as it should, take it to your local RadioShack store for assistance.



SPECIFICATIONS

Number of Keys	61
Polyphonic Sound	16-note (Max.)
Preset Tones	100
Auto-Rhythms	100
Tempo	Adjustable (20–255 Beats Per Minute)
Other	Fill-in and Synchro Start
Accompaniments	Concert Chord, Fingered
Prerecorded Tunes	100 Tunes
Transpose	(F#~C~F: half-notes)
Tuning	Adjustable A4 = 440 Hz ±50 cents
Built-In Speakers	4 ³ / ₄ Inch (12 cm) × 2 (Output 2W + 2W)
Terminals:	
Power Supply	DC 9V Jack
PHONES/OUTPUT Jack	Output Impedance: 50 Ohms Output Voltage: 3.5V (RMS) MAX
MIDI	IN, OUT
SUSTAIN	1/4-Inch Standard Jack
Power Sources	DC: 6 D batteries AC: 120V, 60Hz, with AC adapter
Power Consumption	7.7 W
Dimensions (HWD)	5 ³ / ₈ × 37 ⁷ / ₈ × 14 ¹³ / ₁₆ Inches (143 × 961 × 376 mm)
Weight (Without Batteries)	12 lb 7 oz (5.7 kg)
Included Accessories	Sheet Music Stand <i>Sheet Music and Play Guide for the Prerecorded Tunes</i>

Specifications are typical; individual units might vary. Specifications are subject to change and improvement without notice.

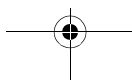



NOTES

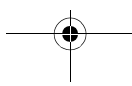
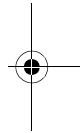
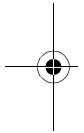

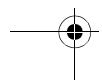
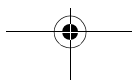
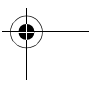
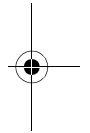
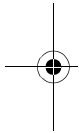
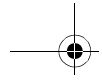



Limited One-Year Warranty

This product is warranted by RadioShack against manufacturing defects in material and workmanship under normal use for one (1) year from the date of purchase from RadioShack company-owned stores and authorized RadioShack franchisees and dealers. EXCEPT AS PROVIDED HEREIN, RadioShack MAKES NO EXPRESS WARRANTIES AND ANY IMPLIED WARRANTIES, INCLUDING THOSE OF MERCHANTABILITY AND FITNESS FOR A PARTICULAR PURPOSE, ARE LIMITED IN DURATION TO THE DURATION OF THE WRITTEN LIMITED WARRANTIES CONTAINED HEREIN. EXCEPT AS PROVIDED HEREIN, RadioShack SHALL HAVE NO LIABILITY OR RESPONSIBILITY TO CUSTOMER OR ANY OTHER PERSON OR ENTITY WITH RESPECT TO ANY LIABILITY, LOSS OR DAMAGE CAUSED DIRECTLY OR INDIRECTLY BY USE OR PERFORMANCE OF THE PRODUCT OR ARISING OUT OF ANY BREACH OF THIS WARRANTY, INCLUDING, BUT NOT LIMITED TO, ANY DAMAGES RESULTING FROM INCONVENIENCE, LOSS OF TIME, DATA, PROPERTY, REVENUE, OR PROFIT OR ANY INDIRECT, SPECIAL, INCIDENTAL, OR CONSEQUENTIAL DAMAGES, EVEN IF RadioShack HAS BEEN ADVISED OF THE POSSIBILITY OF SUCH DAMAGES.

Some states do not allow the limitations on how long an implied warranty lasts or the exclusion of incidental or consequential damages, so the above limitations or exclusions may not apply to you.

In the event of a product defect during the warranty period, take the product and the RadioShack sales receipt as proof of purchase date to any RadioShack store. RadioShack will, at its option, unless otherwise provided by law: (a) correct the defect by product repair without charge for parts and labor; (b) replace the product with one of the same or similar design; or (c) refund the purchase price. All replaced parts and products, and products on which a refund is made, become the property of RadioShack. New or reconditioned parts and products may be used in the performance of warranty service. Repaired or replaced parts and products are warranted for the remainder of the original warranty period. You will be charged for repair or replacement of the product made after the expiration of the warranty period.

This warranty does not cover: (a) damage or failure caused by or attributable to acts of God, abuse, accident, misuse, improper or abnormal usage, failure to follow instructions, improper installation or maintenance, alteration, lightning or other incidence of excess voltage or current; (b) any repairs other than those provided by a RadioShack Authorized Service Facility; (c) consumables such as fuses or batteries; (d) cosmetic damage; (e) transportation, shipping or insurance costs; or (f) costs of product removal, installation, set-up service adjustment or reinstallation.

This warranty gives you specific legal rights, and you may also have other rights which vary from state to state.

RadioShack Customer Relations, 200 Taylor Street, 6th Floor, Fort Worth, TX 76102

We Service What We Sell

04/99

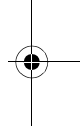
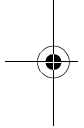

RadioShack
A Division of Tandy Corporation
Fort Worth, Texas 76102

10A99
MD1150E-1

Printed in Malaysia
MA9906-A

